



Solar Shading Systems

Shadoglass and Shadovoltaic



Introduction

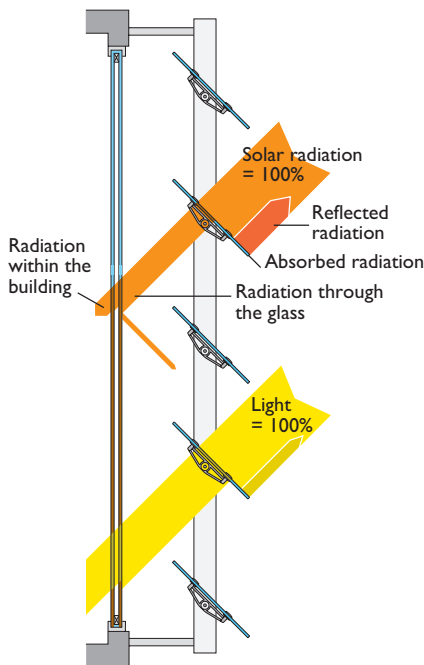

Front cover image:

Colt has supplied a controllable Shadoglass LS-2 system to the Consolidated Forensics Laboratory (CFL) in Washington DC as a louvre screen in 3 banks, covering the south façade of this huge building. It is controlled by a Colt ICS 4-Link sun tracking system. Prior to installing them Colt conducted successful accelerated life cycle tests on a full scale mock up at an independent test house”.

WHAT IS THE ISSUE?

Excessive solar heat gain and solar glare can be a costly and unwanted hindrance for building owners. In addition, local building regulations increasingly require designers to reduce heat gain, with solar shading recommended as a preventative measure unless glass areas are minimised.

Colt solar shading systems offer designers the opportunity for distinctive architectural impact, whilst reducing solar heat gains.

SOLAR RADIATION & LOUVRES

External solar shading is one of the most effective ways to control the internal conditions of a building.

Radiation from the sun is largely transmitted, absorbed and reflected by the louvres, minimising transmission.

As a result solar heat gain is prevented from passing into the building, minimising ventilation requirements and reducing cooling loads. If a controllable system is installed, adjustable louvres track the position of the sun, thereby optimising the avoidance of overheating. Equally, in winter the louvres may be adjusted in such a way that the building benefits from the heat from the sun, and they can be closed at night reducing heat loss.

Similarly, daylight levels can be enhanced, and levels of glare reduced.

COLT'S OFFER

- Calculation of sun paths, shading angles and heat loads
- Selection of the most appropriate system from a wide range of options.
- Louvre panels are available in various configurations, materials, finishes and coatings to meet the requirements of almost any project
- Two advanced control options are available, ICS 4-Link for large or medium sized projects and Soltronic for smaller projects
- All systems are durable and reliable with low maintenance needs.

WHAT COLT CAN OFFER YOU

Colt has more than 40 years experience with designing solar shading solutions.

With operating companies located worldwide, Colt has a broad product portfolio to meet your needs.

Colt was the first to incorporate electricity generating photovoltaic cells into solar shading louvres. Colt understands that a low energy building fails on its weakest link, so it can provide integrated solutions that cover many aspects of a design, including solutions to enhance the use of natural daylight and natural ventilation.

Colt is dedicated to innovation and has a comprehensive design capability, including prototyping and testing facilities. We would welcome the opportunity to develop solutions to match your unique requirements.

“People feel better in Colt Conditions.”

Introduction

TYPICAL SUN PATHS AND LOUVRE ANGLES FOR A BUILDING IN NORTHERN EUROPE

Sun Path Diagrams

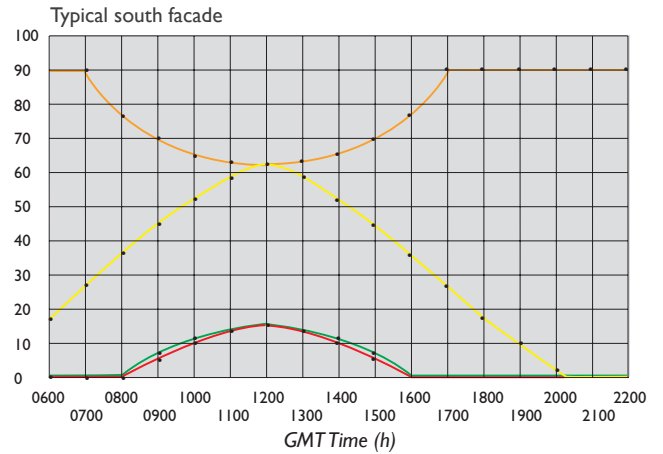
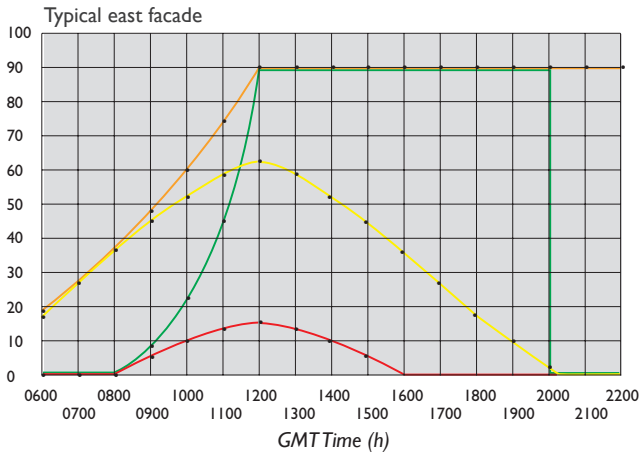

- Sun altitude in summer
- Louvre angle in summer (June)
- Sun altitude in winter
- Louvre angle in winter (Dec)

Notes:

1. When louvre angle > 90° - facade is in the shade.
2. Normally the angle of the louvre follows the VSA (vertical shadow angle). When shading is not required (i.e. when facade is in the shade or when the sky is overcast), the louvres may be set for maximum daylight entry or vision to the outside, or be closed for night security and improved insulation.

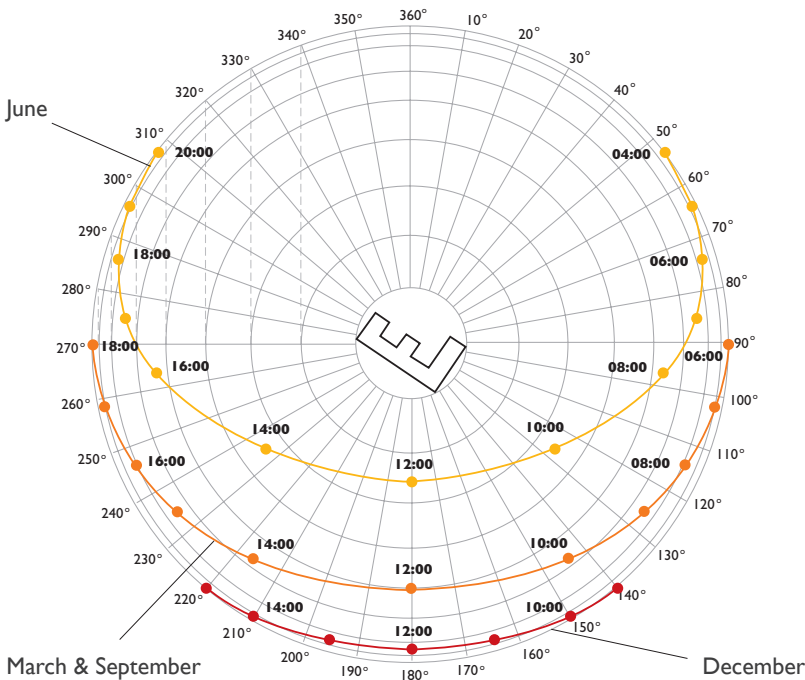

TOTAL CONTROL

Although fixed solar shading performs well on a South facing facade, performance is dramatically reduced on an East or West facing facade which receives a large amount of sunshine during the day.

A controllable shading system can best overcome this problem. Sun tracking louvres follow the path of the sun, making sure the solar shading system always optimises the protection against solar heat gain.

On dull or overcast days the louvres are controlled in such a way that if clouds pass over the building, the louvres will automatically open to maximise daylight entry and then later revert back to their original position.

The Sun path diagram (left) for latitude 52°N shows the position of the sun throughout the day during the months of June, March, September and December.

Bristol harbourside, UK.

As part of the development in Bristol, Colt installed Shadoglass glass louvres so as to help to reduce the solar heat gain entering the buildings.



Galizia fashion shop, Metzingen, Germany

In concert with the building's designers, Colt provided a fine building envelope covering the sales floors of this renowned fashion shop. The vertically installed glass louvres, each with a turning area of 180°, follow the faceted shape of the building façade.



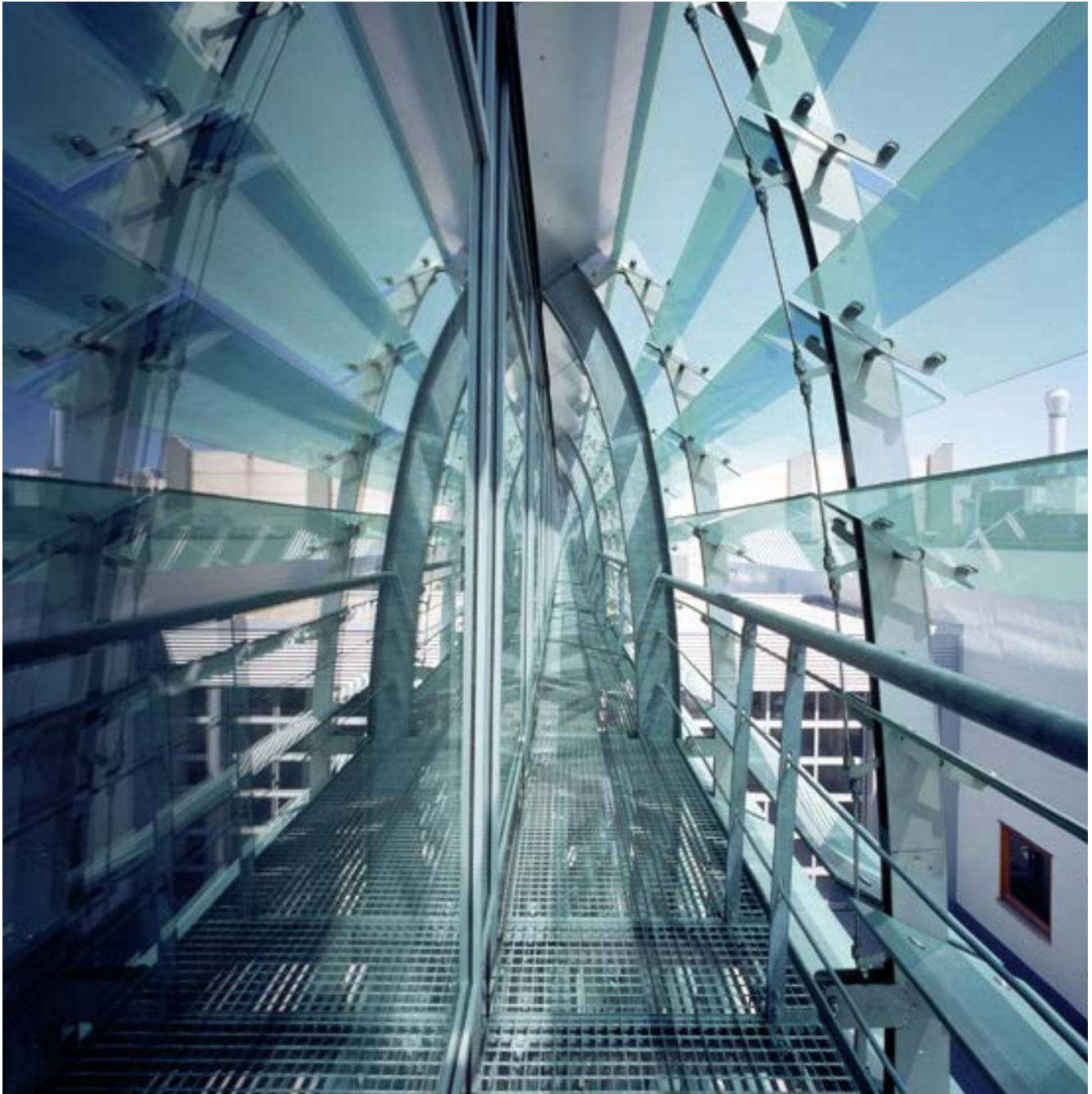

Grünewald, Germany.

Colt Shadoglass louvres mounted onto a structural stainless steel supporting framework in front of the façade of the Grünewald building in Bocholt, Germany. A Colt ICS 4-Link control system calculates the progression of the sun and sends signals to automatically alter the position of the louvres.

Shadoglass

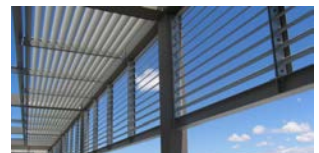

Shadoglass describes a fixed or controllable external solar shading system that incorporates glass louvres. A Shadoglass shading system can reduce solar heat gain, lower air conditioning running costs, and lessen glare whilst maximising the use of natural daylight. The glass louvres are available in various colours, surface finishes and coatings to meet specific design requirements.

This enables the designer to control the quality of light entering the building. Photovoltaic cells may be integrated into the glass so as to obtain further energy benefits.

- Available as standard in widths of up to 600mm.
- Available in unsupported spans of up to 2m, supported spans of up to 4m (depending on windloads and other criteria).
- Wide range of colours, surface finishes and coatings.
- All principal support components manufactured from corrosion-resistant extruded aluminium alloy with stainless steel fixings.
- Fixed or controllable.
- May permit the integration of photovoltaic cells.

Shadovoltaic

Shadovoltaic describes a fixed or controllable external solar shading system that incorporates glass louvres with photovoltaic cells integrated into the glass so as to generate electricity at the same time as providing shading. The louvres are available in various colours, surface finishes, patterns and coatings to meet specific design requirements.

Both monocrystalline and polycrystalline cells may be used. The photovoltaic cells may be integrated into the glass, either by attaching them onto the reverse side of the glass panels or by laminating them between two sheets of glass.

- Combines the functions of solar shading with the generation of electrical power.
- Available in widths of up to 600mm.
- Available in supported spans of up to 4m (depending on windloads and other criteria).
- Wide range of colours, surface finishes, cell patterns and coatings.
- All principal support components manufactured from corrosion-resistant extruded aluminium alloy with stainless steel fixings
- Fixed or controllable.

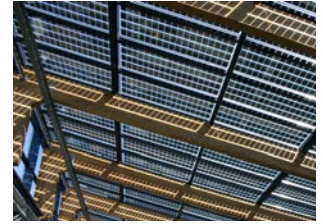

Hotel de Ville, Montpellier.

Colt installed a solar shading solution to the new Hotel de Ville designed by Architect Jean Nouvel.

The building is very eco-friendly and hosts a photovoltaic power generation array of 1,400 m², one of the largest in France.

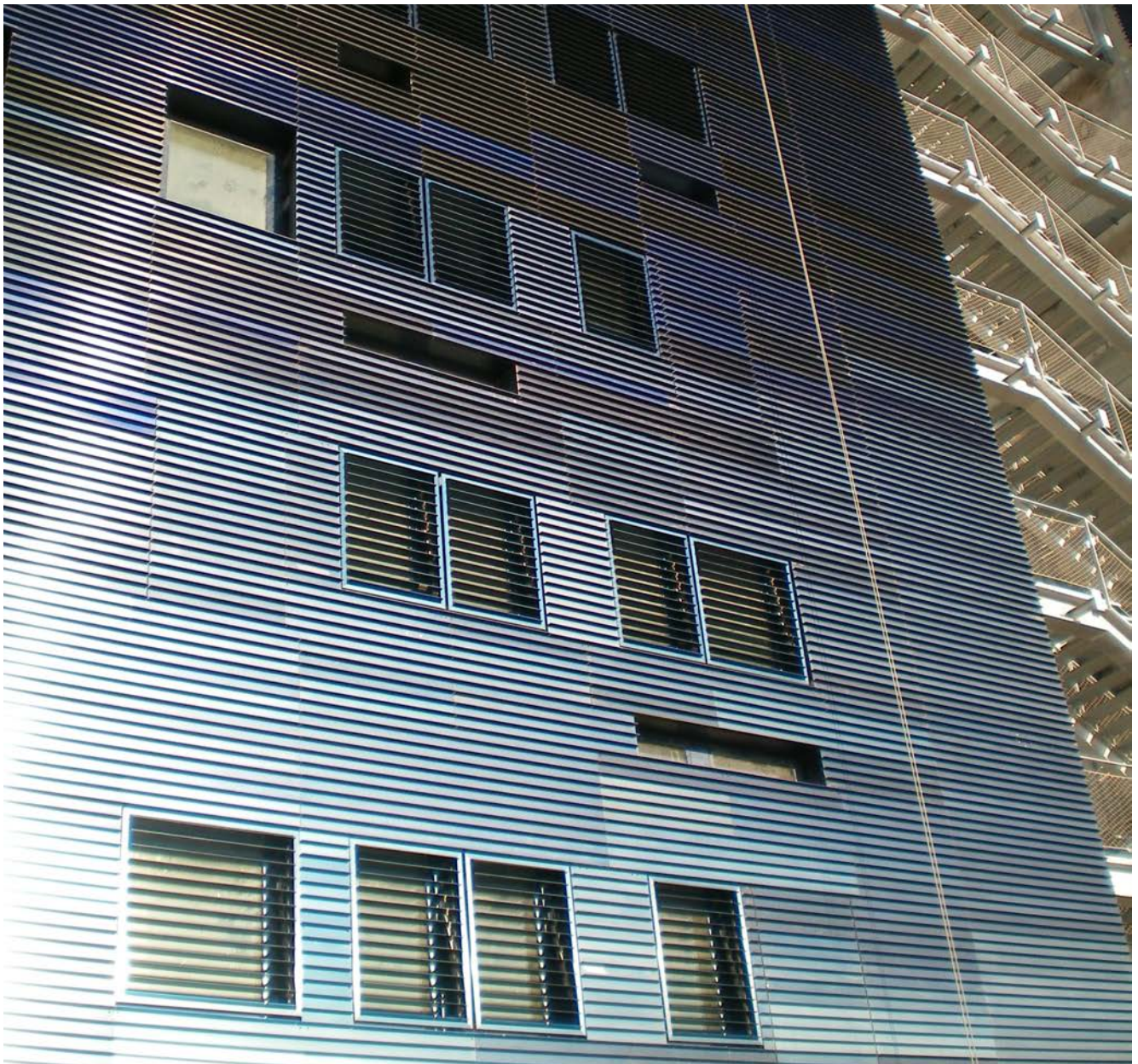

Carrier System I

Intended for wider spans, carrier system I incorporates a central aluminium torsion tube along the length of the louvre, and is ideal for continuous facades, as well as for roofs.

For glass, cross sectional louvre widths from 300mm and up to 600mm are available.

This carrier system is also suited for use with metal, fabric, wood, terracotta clay and translucent acrylic louvres.

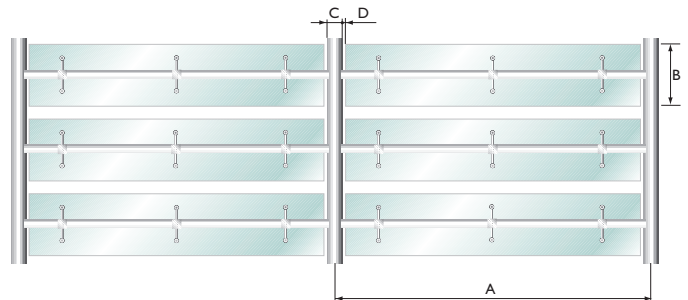
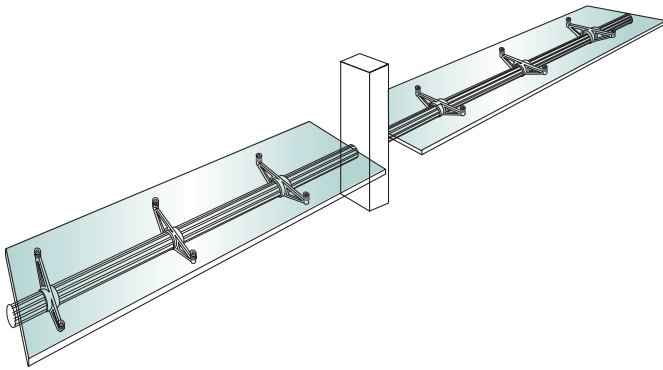
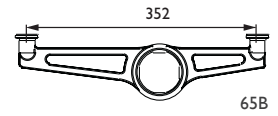
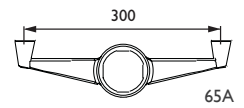
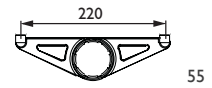

Ørestadens Gymnasium, Denmark

This building was designed by the famous 3XN Danish international architects. This project involved the design and installation of 1700m² laminated and printed bespoke Shadoglass glass louvres.



Königsbau Passagen, Germany.

Located in Germany the "Königsbau" building was designed by the award-winning practice of Berlin Architects Hascher. 2,400 m² of Colt Shadoglass glass louvres have been arranged in five rows, each 24 metres long, providing a transparent, rain-proof external skin. The rooflight has been designed to adroitly meet with the aesthetic and functional demands of the building, and, in the event of a fire, to act as a smoke and heat exhaust system.

GLASS PARAMETERS TABLE

Dimensions	LSI - 55	LSI - 65A	LSI - 65B
A mm (max)	2500	3300	3300
B mm	300 - 500	350 - 550	420 - 600
C mm	60	60	60
D mm	10	10	10
Angle of rotation °	0 - 100	0 - 100	0 - 100
Torsion tube Ømm	55	65	65

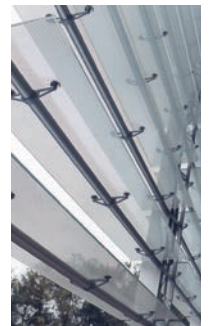

Note: Table to be used as a guide only.
Allowable dimensions depend upon the specific requirements of the project.

Carrier System 2

Primarily intended for smaller spans or where frequent anchor points are available, carrier system 2 provides minimum obstruction to the glass area, thereby maximising daylight and enhancing the view to the outside.

For glass, carrier system 2 is available with cross sectional louvre widths of up to a maximum of 500mm.

This carrier system is also suited for use with metal, fabric, wood, terracotta clay and translucent acrylic louvres.

Straight carrier bracket

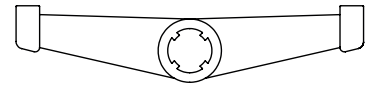

Plan view of LS2-30A bracket

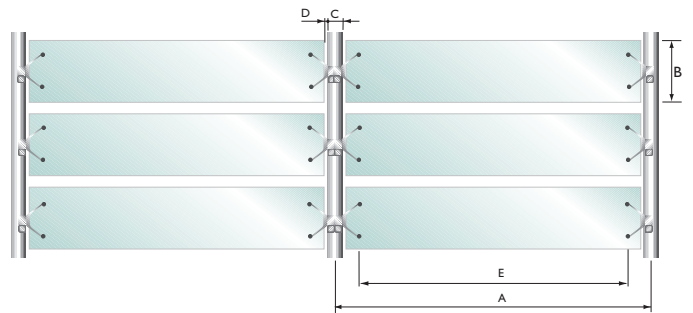
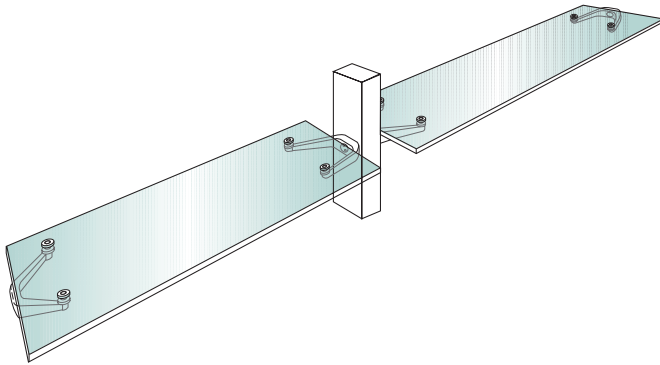
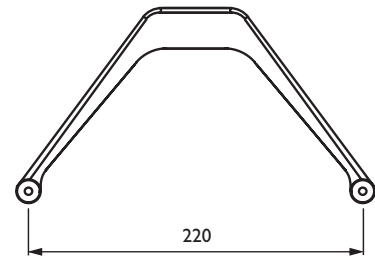



Lysaker Park, Norway.

Colt installed a Shadoglass solar shading system to the Lysaker Park office building to reduce the amount of glare and solar heat gain within the building.

GLASS PARAMETERS TABLE

Dimensions	LS2-30
A mm (max)	2000
B mm	500
C mm	60
D mm	10
E mm	1700
Angle of rotation °	0 - 100



Note: Table to be used as a guide only.

Allowable dimensions depend upon the specific requirements of the project.

Carrier System 3

Like System 1, carrier system 3 is intended for wider spans and incorporates a discreet central aluminium torsion tube along the length of the louvre. It is ideal for continuous facades as well as for roofs.

For glass, louvre spans of up to 4000mm long can be achieved without any additional supporting structure.

Glass louvres can have a cross sectional width of up to 600mm.

This carrier system is also suited for use with metal, fabric, wood, terracotta clay and translucent acrylic louvres.

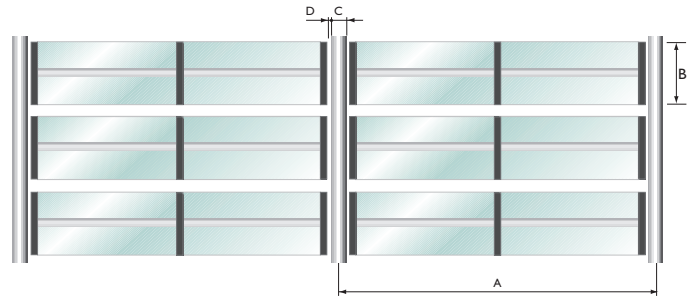
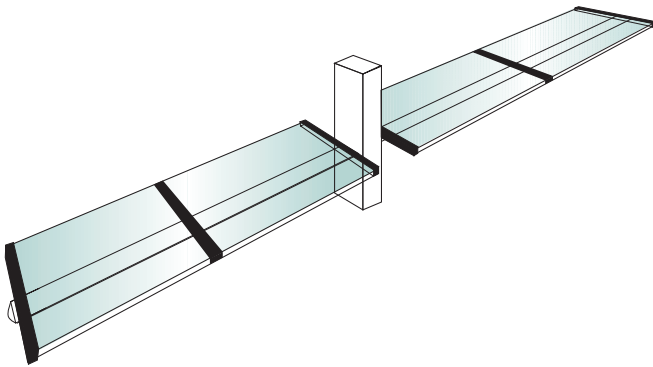
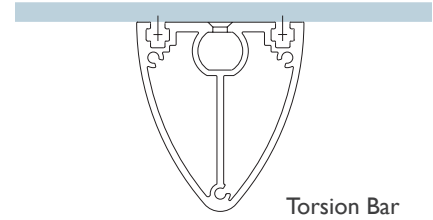



SBL Offices, Austria.

GLASS PARAMETERS TABLE

Dimensions	LS3
A mm (max)	4000
B mm	600
C mm	60
D mm	5
Angle of rotation°	0 - 100



Note: Table to be used as a guide only.

Allowable dimensions depend upon the specific requirements of the project.

Carrier System 4

Carrier systems 1, 2, 3 and 5 are pivoted systems which require the supports to be connected to each side of the louvre. System 4 provides a back hung design solution with hidden control mechanisms integrated within the main vertical supports. This allows for seamless continuous louvres with unobtrusive supports when viewed from the outside, as the louvres are installed in front of the supports.

For glass, carrier system 4 is suitable for spans of up to 1800mm in length. It can utilise cross sectional louvre widths of up to 600mm, incorporating photovoltaic cells if required.

This carrier system is also suited for use with metal, fabric, wood, terracotta clay and translucent acrylic louvres.

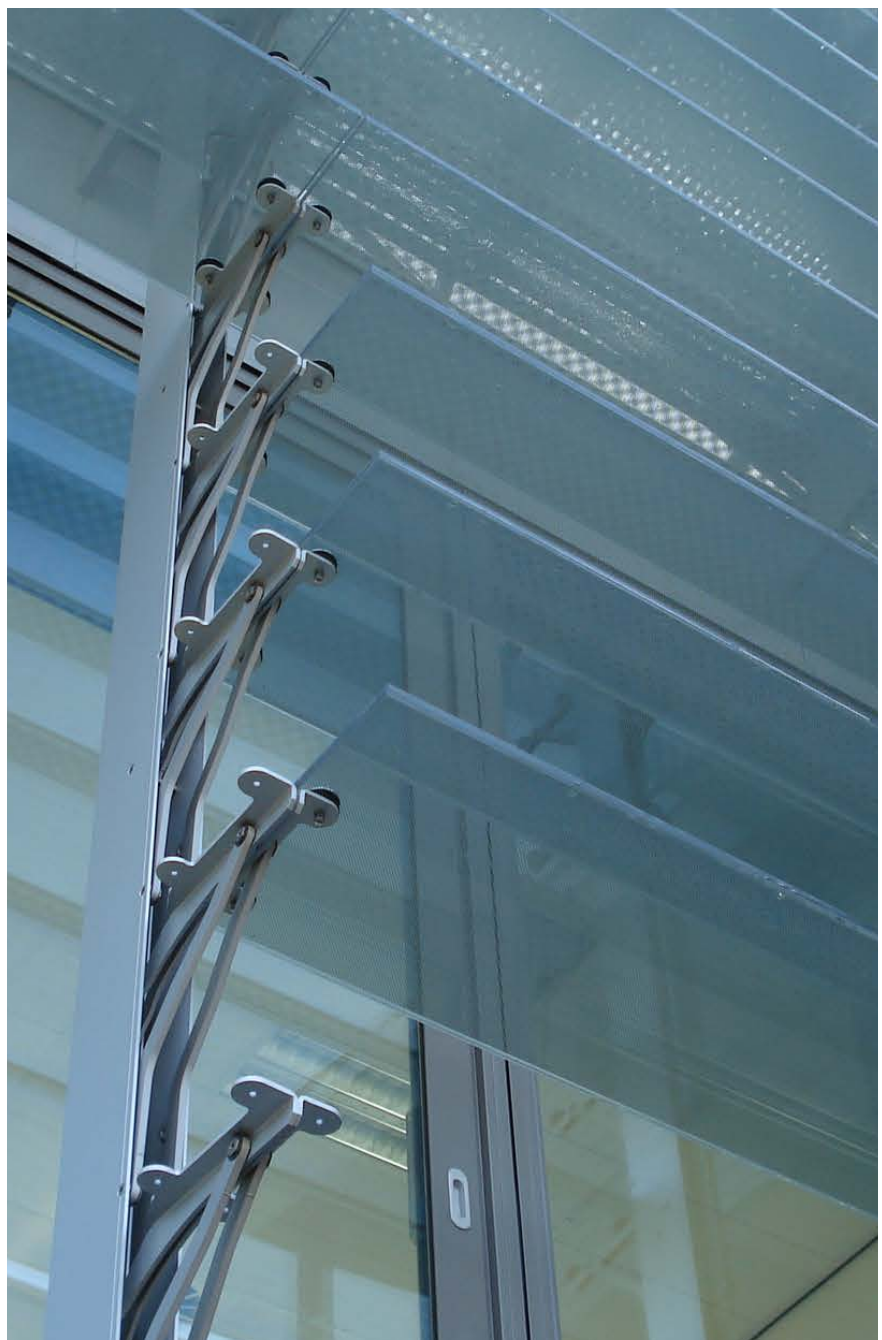
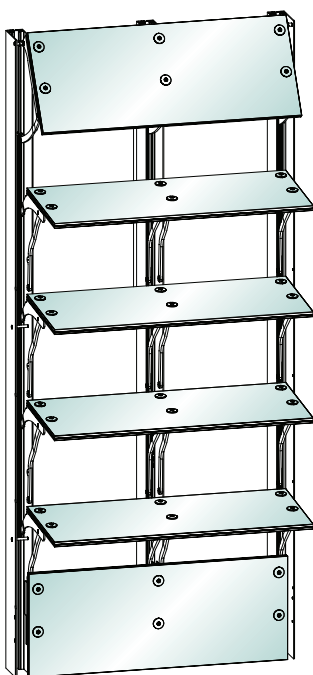
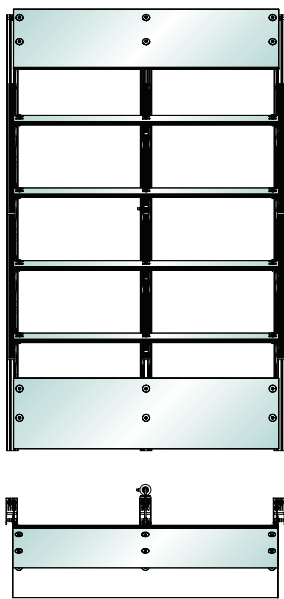
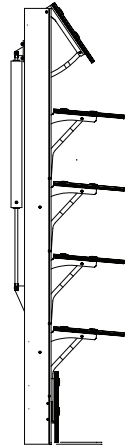



Office building in Linz, Austria

GLASS PARAMETERS TABLE

Dimensions	LS4
A mm (max)	1800*
B mm	min. 350, max. 550
C mm	65
D mm	10
Angle of rotation °	0 - 85



Note: Table to be used as a guide only.

Allowable dimensions depend upon the specific requirements of the project.

*if spanning across an intermediate mullion, max 3600mm.

Carrier System 5

Carrier system 5 is a fully centre pivoted system which provides maximum transparency. Louvres are supported at each end by a bonded and extruded end cap.

For glass, louvre spans of up to 1800mm long can be achieved without any additional support work. This system can utilise cross sectional louvre widths of up to 600mm.

System 5 is ideal for either horizontal or vertical applications.

This carrier system is also suited for use with metal, fabric, wood, terracotta clay and translucent acrylic louvres.

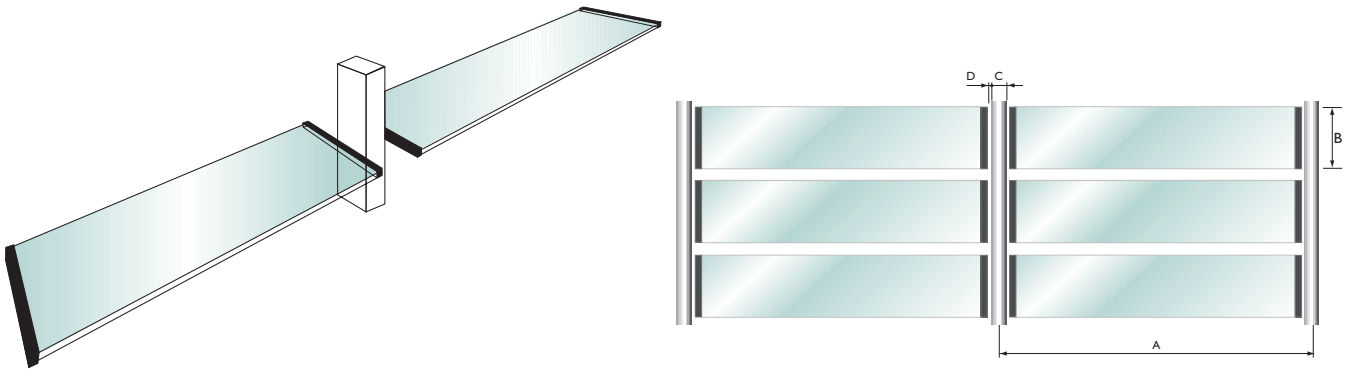

Cork County Hall, Ireland.



Hoofkantoor, Bergopwaarts.

An installed Shadoglass solar shading system. A Shadoglass controllable or fixed glass louvre shading system can reduce solar heat gain, lower air conditioning running costs, and lessen glare whilst maximising the use of natural daylight.

GLASS PARAMETERS TABLE

Dimensions	LS5
A mm (max)	1800
B mm	600
C mm	50/60
D mm	10
Angle of rotation °	0 - 100



Note: Table to be used as a guide only.

Allowable dimensions depend upon the specific requirements of the project.

Bespoke Louvre Systems

Specially designed in collaboration with you to meet your specific project requirements on larger projects.

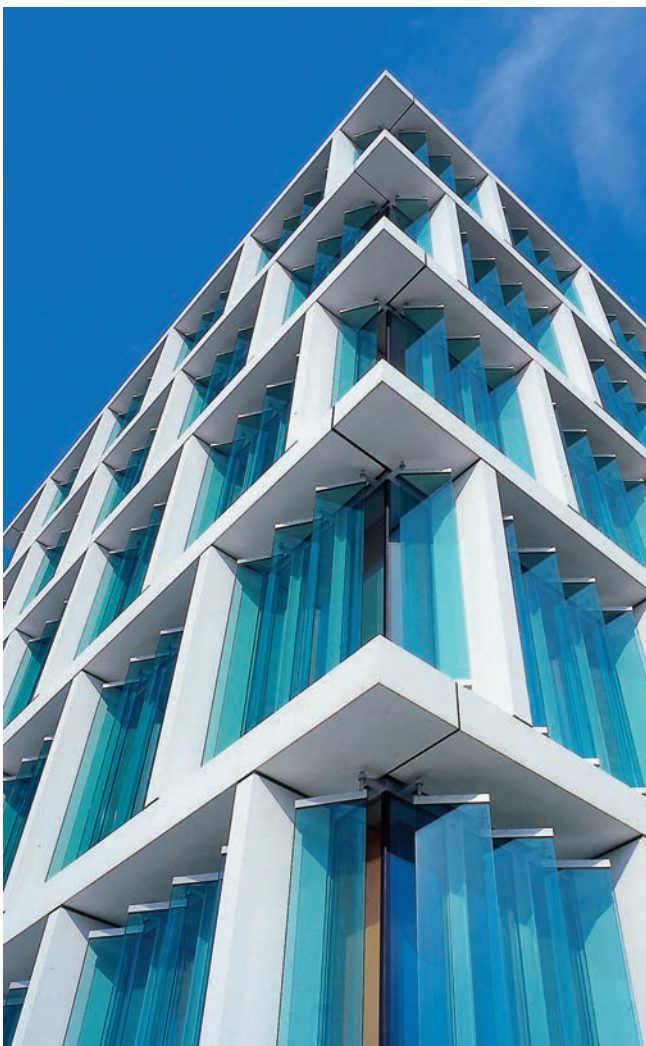

Controls

Colt Solar Shading systems may be controlled in two different ways:

- Hand control via lever or crank handle
- Electrically operated via actuators, which require a controller such as ICS 4-Link, SolTronic or a client BMS.

ICS 4-LINK

ICS 4-Link is ideally suited to larger projects with more complex control requirements.

It is a generic control system that can operate solar shading and natural ventilation systems.

It has a wide variety of operating modes, including sun tracking, daylighting optimisation and PV illumination. It responds to timers and sensors to ensure that the building 'reacts' appropriately to the sun's position and to the weather.

Remote operation is available via an internal modem interface and a manual override is also possible.

SOLTRONIC

SolTronic is ideally suited for small to medium sized projects.

It is a simplified version of ICS 4-Link and can control up to 15 groups of actuators, each group containing 15 actuators, with individual motor control.

Commissioning is extremely straightforward.

Soltronic responds to external weather conditions automatically calculating the position of the sun, and adjusts the position of the louvres accordingly.





WHAT COLT CAN OFFER YOU

Colt has more than 40 years experience with designing solar shading solutions.

With operating companies located worldwide, Colt has a broad product portfolio to meet your needs.

Colt was the first to incorporate electricity generating photovoltaic cells into solar shading louvres. Colt understands that a low energy building fails on its weakest link, so it can provide integrated solutions that cover many aspects of a design, including solutions to enhance the use of natural daylight and natural ventilation.

Colt is dedicated to innovation and has a comprehensive design capability, including prototyping and testing facilities. We would welcome the opportunity to develop solutions to match your unique requirements.

COMMISSIONING

Proper commissioning by experts is essential. We recommend that our specialist staff commission and certify the system.

COLT SERVICE

Part of the Colt Group of companies, Colt Service offers a comprehensive range of maintenance packages incorporating the maintenance and repair of all building services equipment including non Colt products.

Colt Service provide a 24 hour, 365 day emergency cover as standard.

MAINTENANCE & TESTING

Colt solar shading systems require virtually no maintenance.

All components of any system should be serviced at least once a year and tested monthly.



“People feel better in Colt conditions”

Architectural Solutions	Colt International Limited
Climate Control	New Lane Havant
Smoke Control	Hampshire PO9 2LY
Service and Maintenance	Tel +44(0)23 9245 1111
	Fax +44(0)23 9245 4220
	info@coltgroup.com
	www.coltgroup.com